



PERFORMANCE CURVES

2023-10-2€

Page 2 / 3

DAB PUMPS S.p.A.
Via Marco Polo, 14 - 35035 Mestrino (PD), Italy
Tel. +39 049 5125000 - Fax +39 049 5125950
www.dabpumps.com

Receiver

From

Company
Reference
Address
Phone
Fax
E-mail

EUROSWIM 50 M

Curve tolerance according to ISO 9906

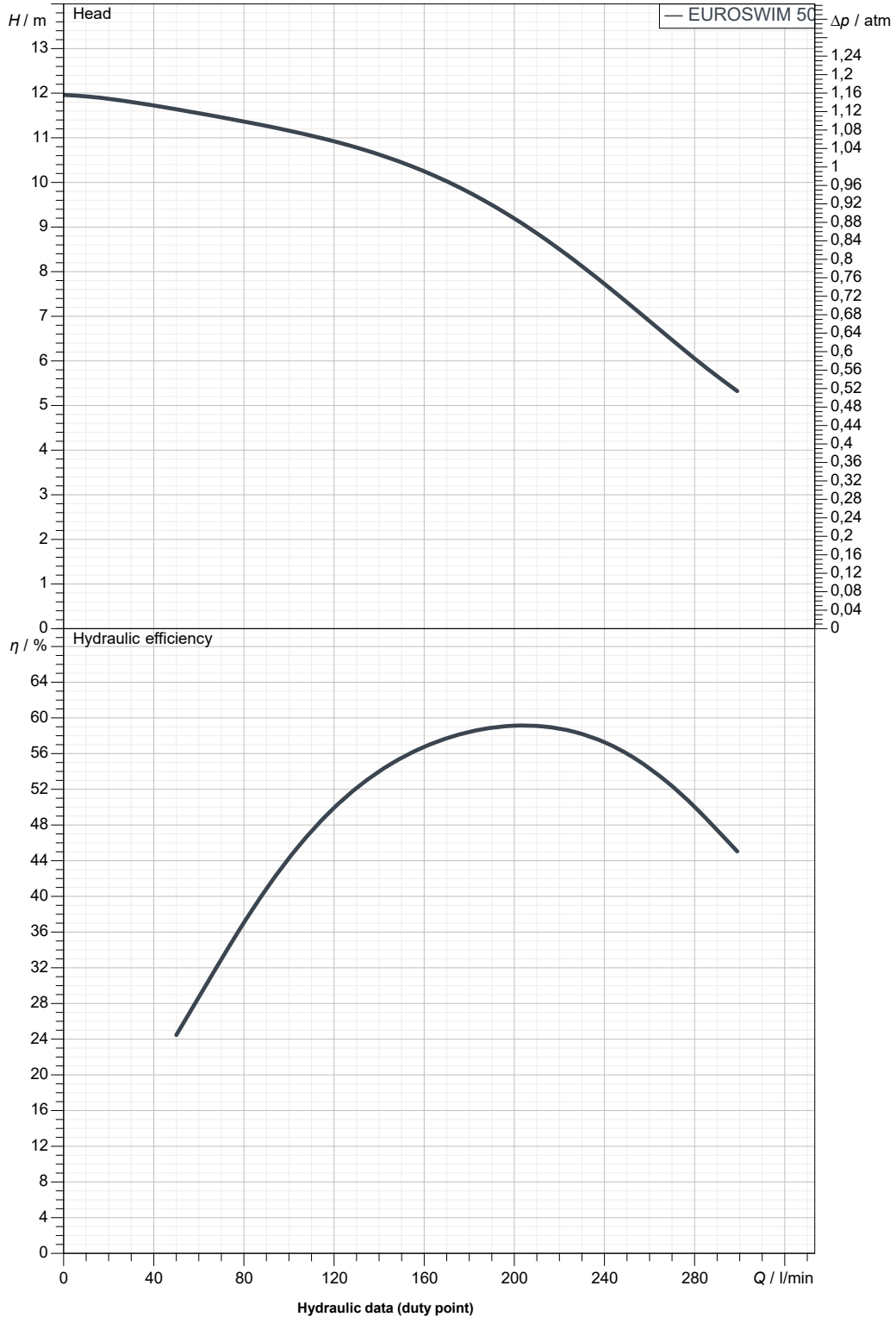

Suction side :
2" G
2,467 atm

Discharge side :
2" G
2,467 atm

Flow :

Head :

Rated speed :
2.800 1/min

MAIN_PROJECT_TITLE

BUSINESS_PROCESS_ID

OWNER_

ISSUE_DATE
2023-10-29



DIMENSIONAL DRAWING

2023-10-29

Page 3 / 3

DAB PUMPS S.p.A.
Via Marco Polo, 14 - 35035 Mestrino (PD), Italy
Tel. +39 049 5125000 - Fax +39 049 5125950
www.dabpumps.com

Receiver

From

Company
Reference
Address
Phone
Fax
E-mail

EUROSWIM 50 M

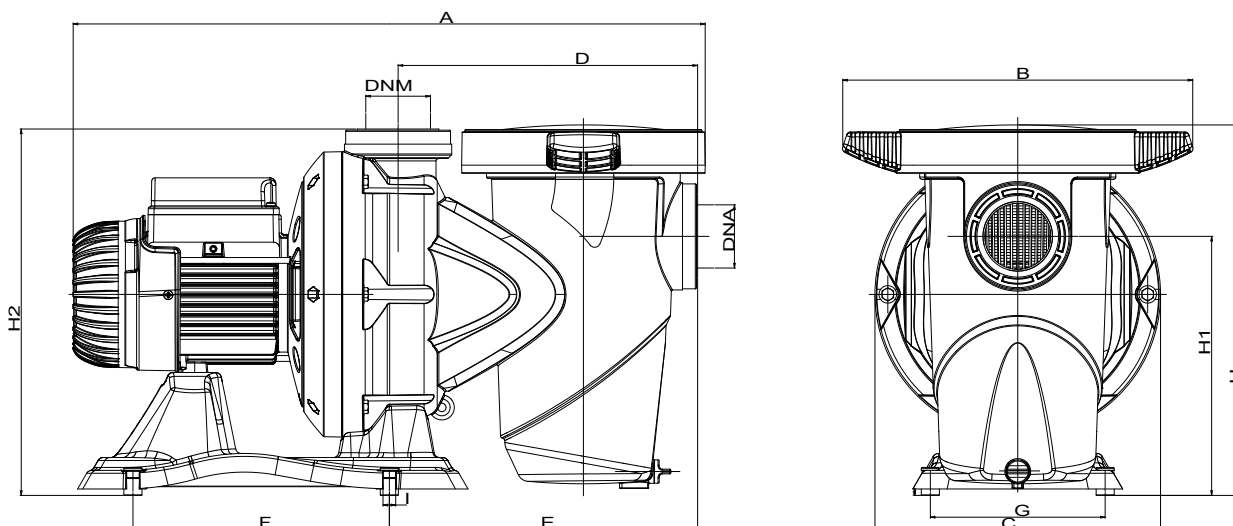

Dimensions in mm

Pump connection

1	A	542	H2	314			
2	B	300	I	11			Suction
3	C	245	L	6,5			2" G
4	D	257					2,467 atm
5	DNA	G2"					
6	DNM	G2"					
7	E	265					Discharge
8	F	220					2" G
9	G	150					2,467 atm
10	H	317					
11	H1	222					

MAIN_PROJECT_TITLE

BUSINESS_PROCESS_ID

OWNER

ISSUE_DATE

2023-10-29